

## ITP200x50-Ø20 flat

EAN 4031582070330

Wielkern van aluminium met gegoten polyurethaan loopvlak, precisiekogellagers

### Technische data

Wieldiameter	200 mm
Bandbreedte	50 mm
Asgat-Ø	20 mm
Naaflengte	60 mm
Temperatuur	- 20 / + 60 °C
Standaard	EN 12532
Eigen gewicht	1.3 kg
Hardheid van de band	A 92 Shore
Dyn. draagvermogen	800 kg
Statisch draagvermogen	1600 kg



Rolweerstand	+	+	+	+	+
Verplaatsingsgeluid	+	+	+	+	+
Strepen	+	+	+	+	+
Roest bescherming	+	+	+	+	+

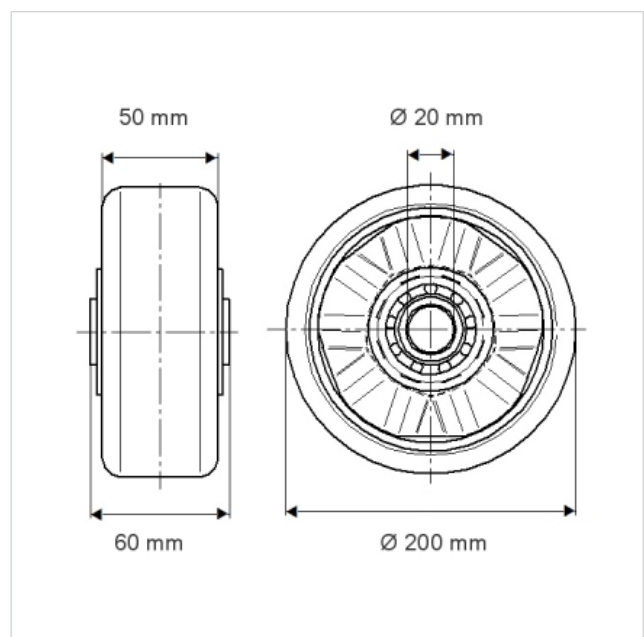



**ITP200x50-Ø20 flat**

EAN 4031582070330

