

STOCKAGE TANKS

Volume 1500 L

Gelieve de juiste hoogtes en diameters aan te duiden op de gewenste plaats

AANZICHT A

AANZICHT B

AANZICHT C

AANZICHT D

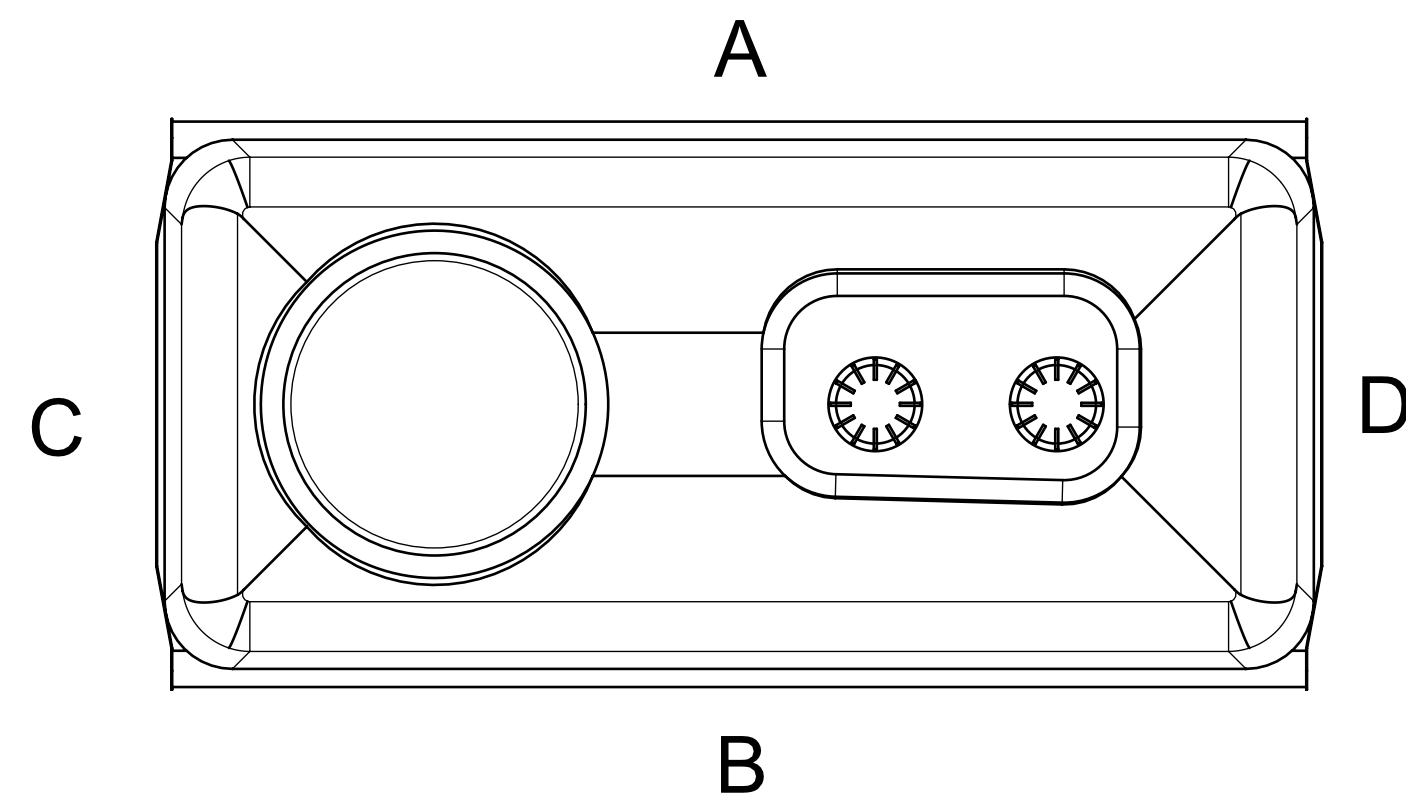
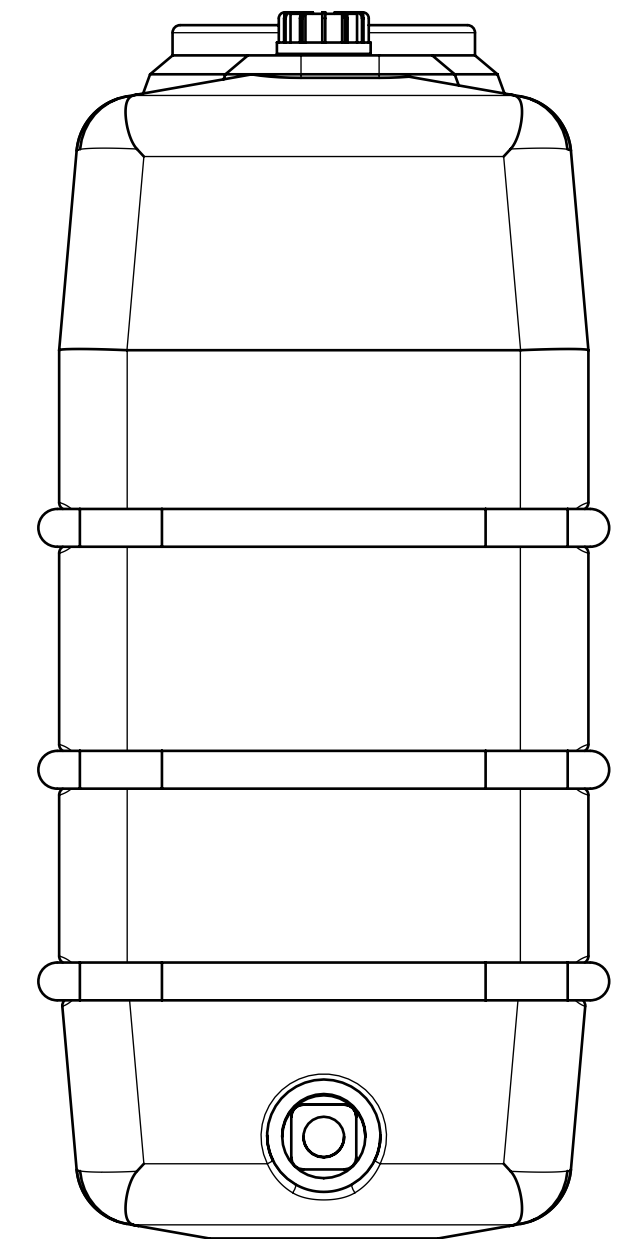
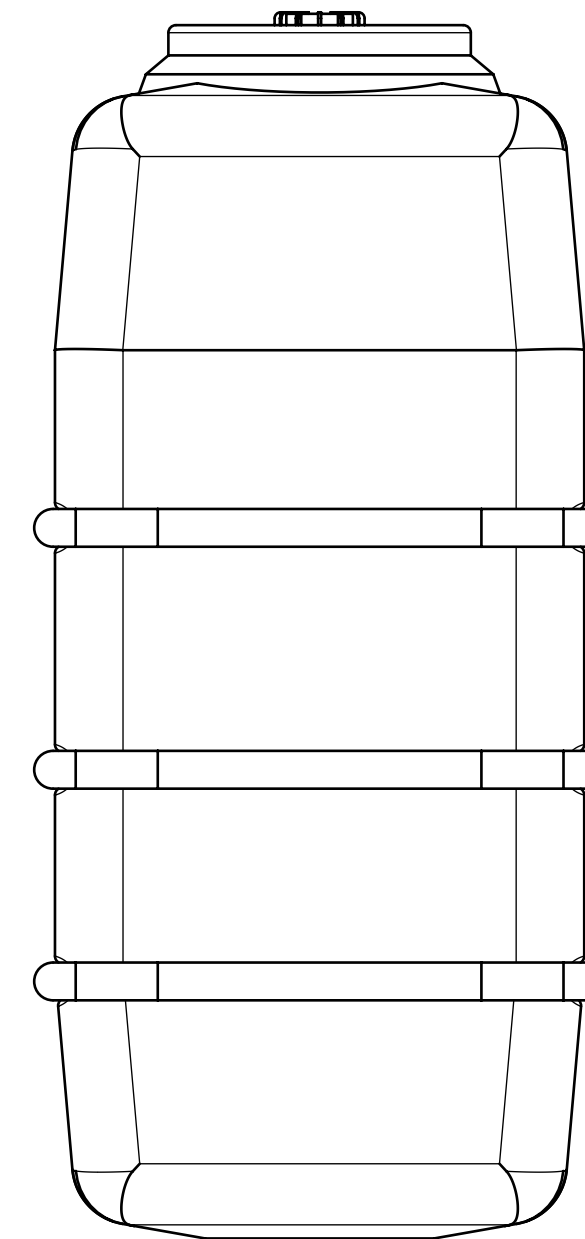
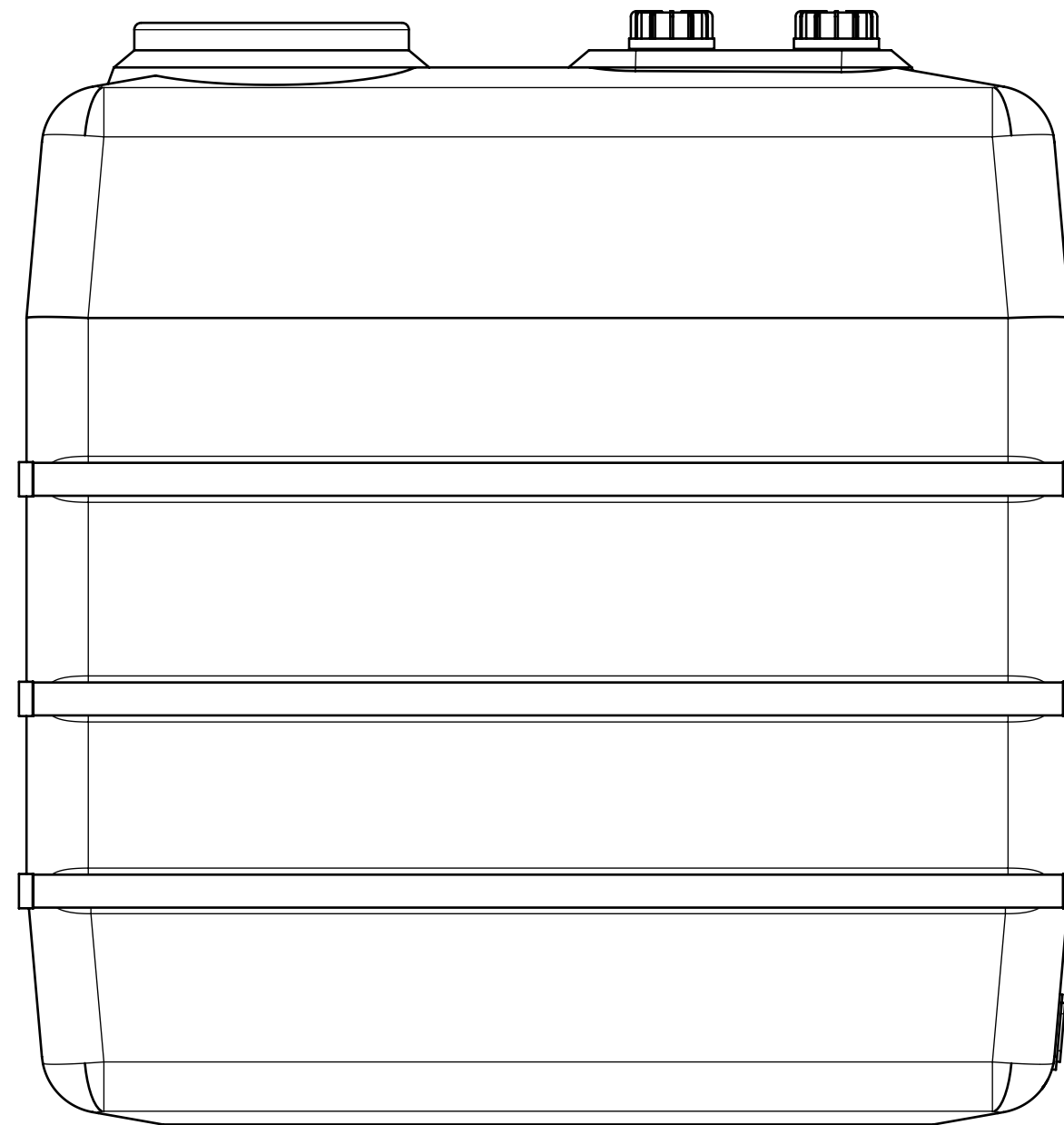
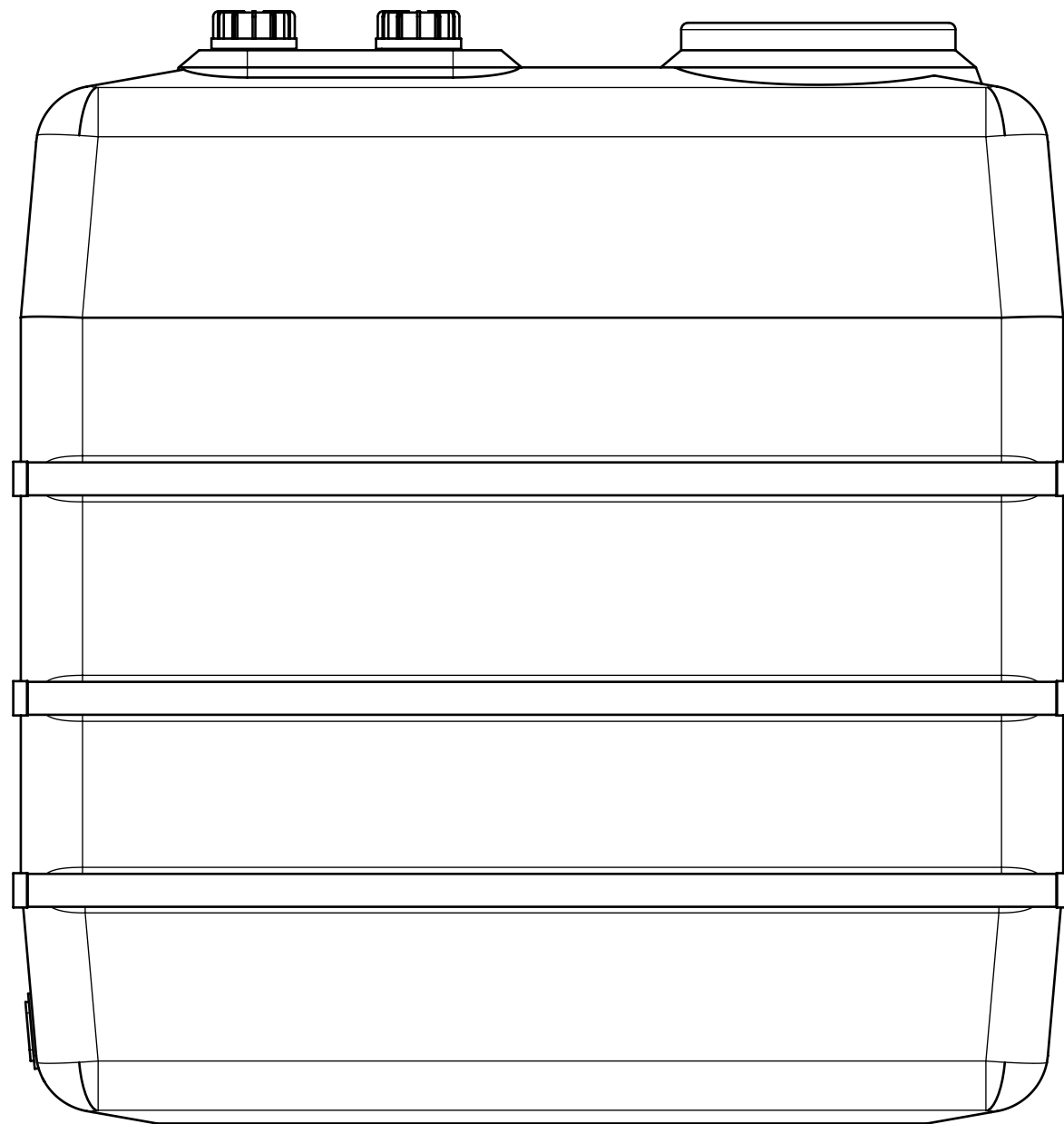

Linear tolerances	Surface roughness	Shape and positioning tolerances	Bend tolerances	Finishing
Drawing name				Material
STOCKAGETANK 1500L				LLDPE
Drawn by	Name	Date	Drawing number	Sheet 1 of 1
Approved by			STOCKAGETANK_1500_2D_0.01.prt	Scale 1 : 10
			unit : MM	Format A2
DS PLASTICS WATERTIGHT SOLUTIONS DS PLASTICS N.V. Mosten 18 9160 Lokeren T: +32 (0)9 280 78 80			All rights reserved. No parts of this concept may be reproduced in any form or by any means without the prior written permission of DS PLASTICS N.V.	